

# VIBRATORY SURFACE FINISHING



Machinery & Consumables

2025 Edition

# About Us

---

We are a family-owned business that has been delivering exceptional service for nearly 50 years. Our expertise extends beyond supplying vibratory equipment, consumables, services and repairs; we believe in building long-term relationships with our customers by offering a range of comprehensive services.



Founder Brian Colwell had an idea and Sharmic Engineering was established in August as an unlimited company with a vision to provide innovative and cost-effective engineering solutions to a wide range of industries.

The origin of our company name, Sharmic, is no coincidence. Brian Colwell, the founder of the company, wanted to create a name that reflected his commitment to family values and the strong ties that bind. Combining the names of his two beloved daughters, Sharon, and Michelle, Shar-mic was born – a name that resonates with the essence of a family-run business.

In our purpose-built facility in Stourport-On-Severn, we have invested in state-of-the-art machinery and innovative technologies to maintain our competitive edge. This forward-thinking approach allows us to adapt to evolving industry demands and consistently deliver innovative solutions to our customers including providing for automotive, aerospace, or pharmaceutical industries, we strive for perfection in every aspect of our work



# Contents

---

<b>1</b>	<b>COMPOUNDS</b>	
	<u>Liquid Compounds</u> .....	3
	<u>Powdered Compounds</u> .....	4
	<u>Paste Compounds</u> .....	5
<b>2</b>	<b>CONSUMABLES</b>	
	<u>Maizorb &amp; Walnut Shell</u> .....	7
	<u>Ceramic Media</u> .....	8
	<u>Plastic Media</u> .....	9
	<u>Porcelain Media</u> .....	10
<b>3</b>	<b>MACHINERY</b>	
	<u>Auto Unload Circular Machine (VRX)</u> .....	11
	<u>Manual Unload Circular Machine (SM)</u> .....	17
	<u>Trough Machinery</u> .....	20
	<u>Single Phase Tumbler</u> .....	25
	<u>Single Phase Rota Barrels</u> .....	27
	<u>Centrifugal Finishing Machine (SM)</u> .....	30
	<u>Centrifugal Rotary Barrel</u> .....	34
<b>4</b>	<b>DRYING MACHINERY</b>	
	<u>Auto Unload Circular Drying (VRK)</u> .....	37
	<u>Centrifugal Drying &amp; Degreasing</u> .....	42
<b>5</b>	<b>MULTI-MACHINERY</b>	
	<u>Auto Multi-Purpose VP/HA</u> .....	45
<b>6</b>	<b>EFFLUENT SYSTEMS</b>	
	<u>Recycling Systems</u> .....	48
<b>7</b>	<b>MAGNETIC FINISHING MACHINERY</b>	
	<u>Magnetic Finishing</u> .....	51
<b>8</b>	<b>ASSOCIATED PRODUCTS</b>	
	<u>Noise Covers/Control Panel</u> .....	54
	<u>Dosing Unit/Waste Pump</u> .....	56
	<u>Weir Tank</u> .....	57
	<u>Example Basic Set-up</u> .....	57





# COMPOUNDS

# LIQUID COMPOUNDS



Liquid compounds typically dilute in the water used for finishing, creating a lubricating and cleaning emulsion. This emulsion interacts with the media and workpieces, influencing surface modification.

**Deburring:** Mild abrasives suspended in the liquid can remove light burrs and imperfections.

**Corrosion Protection:** Corrosion inhibitors within the compound form a protective film on metals, preventing rust and oxidation.

**Neutralising:** Similar to powders, acidic components can neutralise alkaline cleaning residues, prepping surfaces for further treatment.

**Degreasing:** Liquid detergents and surfactants effectively remove oils, greases, and other contaminants from the workpiece surface.

**Descaling:** Weak acids or chelating agents within the liquid can dissolve and remove light to moderate scale build-up on metals.

**Polishing:** Finer abrasives in the solution contribute to a smoother surface finish by removing minor scratches and imperfections.

**Burnishing:** Certain liquid compounds contain burnishing agents like metallic soaps that enhance the shine and reflectivity of metals like brass, copper, and silver.

**Smoothing:** Lubricating properties of the liquid help media glide over the workpiece, promoting a smoother finish on metals and plastics, especially with softer abrasives like pumice.

VIBRATORY FINISHING PROCESS

SKU	MATERIALS	FUNCTION	FERRIUS	NON FERRIUS	DEBURR	DESCALE	DEGREASE	POLISH	BURNISH	PROTECTION	SMOOTHING	NEUTRALISE
ALP37	Universal	Ultrasonic Clean	✓	✓			✓					
SX-1L/Xi/2	Universal	General Purpose	✓	✓	✓			✓		✓	✓	
SX-3L	Bright Surfaces W/ Steel Media	Burnishing	✓	✓					✓			
SX-4L/2	Aluminium/Brass/Zinc	Cleaning/Polishing	✓	✓	✓			✓			✓	
SX-5L	Steel	Cleaning/Polishing	✓	✓	✓			✓		✓	✓	
NORCHEM 80	Copper/Brass/Alum/S Steel	Polishing		✓		✓		✓	✓			
NORCHEM 89	Aluminium/Zinc	Cleaning/Polishing		✓				✓		✓	✓	
NORCHEM 150	Cast Iron/Steel	Cleaning/Polishing	✓	✓				✓	✓	✓	✓	✓
NORCHEM HILITE	Pewter/Silver/Gold/Plastic/Rubber	Polishing		✓				✓	✓		✓	
SX-9L	Stainless Steel	Polishing		✓				✓	✓			
SX-10L	Brass/Copper/Steel/Aluminium	Acidic Cleaning/Polish	✓	✓	✓	✓	✓	✓	✓		✓	
SX-12L	Reduces Excess Foam	Antifoam	✓	✓								
SX-16L	Tin/Pewter/Silver	Polishing	✓	✓	✓			✓	✓	✓		
SX-19L/S	Steel/Stainless Steel	H/D Degrease	✓	✓			✓	✓		✓		✓
SX-20L	Brass/Copper/Aluminium	Polishing		✓				✓	✓		✓	
SX-22L	Steel	Dewatering Oil	✓							✓		
SX-25L	Steel & Non Ferrous	Degreaseing	✓	✓			✓	✓			✓	
SX-90L	Steel/Stainless Steel/Aluminium	Polishing	✓	✓			✓	✓			✓	
RPP2	Steel	Inhibitor	✓					✓		✓		
RP19L/S	Steel	Degrease/Inhibitor	✓				✓	✓		✓		✓

# POWDERED COMPOUNDS

## SX COMPOUND POWDERS: ACHIEVING THE FLAWLESS FINISHING

Vibratory finishing powder compounds are specially formulated to be mixed with water, media and added to a vibratory finishing machine. As the bowl vibrates, the media and compound mixture tumble against the workpieces, achieving various surface modifications.

Here's a breakdown of their key functions::

- **Deburring:** Coarse abrasive compounds effectively remove burrs and sharp edges left behind from machining or casting processes.
- **Corrosion Protection:** Compounds form a protective layer on metals like steel and aluminium, inhibiting rust and corrosion.
- **Neutralising:** Acidic compounds neutralise the effects of alkaline cleaning solutions used prior to finishing, ensuring optimal adhesion of subsequent coatings.
- **Degreasing:** Compounds effectively remove oils, greases, and other contaminants from the workpiece surface, preparing it for further processing.
- **Descaling:** Compounds dissolve and remove oxides and scales formed on metals during heat treatment or exposure to harsh environments.
- **Polishing:** Finer abrasive compounds remove minor scratches and imperfections, resulting in a smoother and more reflective surface.
- **Burnishing:** Compounds impart a high lustre and mirror-like finish to metals like brass, copper, and silver.
- **Smoothing:** Compounds gently remove surface irregularities and achieves smooth, matte finish on plastics and softer metals.



SKU	MATERIALS	FUNCTION	FERRIUS	NON FERRIUS	DEBURR	DESCALE	DEGREASE	POLISH	BURNISH	PROTECTION	SMOOTHING	NEUTRALISE
SX-11	Steel/Stainless Steel/Brass	Grinding/Lapping	✓	✓	✓					✓		
SX-21	Copper/Brass	Fine Lapping		✓		✓			✓			
SX-25	Steel/Stainless Steel/Iron	Polishing	✓							✓		
SX-30	Aluminium/Zinc	Light Deburr		✓								
SX-31	Gold/Silver/Pewter	Light Deburr/Smooth	✓	✓	✓					✓	✓	
SX-32	Zinc/Aluminium/Steel	Medium Abrasive	✓		✓					✓	✓	
SX-33	Diecasting/Steel/S Steel	Fine Lapping	✓	✓	✓					✓	✓	
SX-35/S	Universal	Pre-Plate/Anodising	✓	✓	✓						✓	
SX-42	Aluminium/Zinc	Degreasing		✓			✓					✓
SX-43	Steel/Stainless Steel	Strong Degrease	✓				✓			✓		
SX-45	Pewter	Neutral Cleaner		✓				✓			✓	✓
SX-46	Steel/Stainless Steel	Fine Lapping	✓					✓	✓	✓	✓	
SX-52	Steel/Stainless Steel	Polishing	✓					✓	✓	✓	✓	
SX-60	Silver/Tin/Pewter	Polishing		✓				✓	✓			
SX-62	Stainless Steel/Aluminium	Polishing		✓					✓			
SX-63	Gold/Copper Alloy	Grinding/Lapping		✓				✓	✓	✓		
SX-80	Stainless Steel	Fine Lapping		✓				✓	✓			
SX-81	Steel/Cast Iron	Polishing	✓			✓						
PUMICE	Cast Resin Parts	Polishing		✓	✓			✓			✓	

# PASTE COMPOUNDS

Choosing the right paste compound depends on your specific material, desired finish, and processing parameters. Why not ask for our recommendations for the optimal results.

Paste compounds are available for a variety of applications, including:

**Steel and Stainless steel:** **EUROPASTE 125** tackles them head-on with efficient material removal while protecting edges from unwanted rounding. It leaves behind a superior surface finish without excessive heat generation.

**Steel, Brass and Copper:** **EUROPASTE 150** Offers a fine lapping process, removing imperfections before polishing. It minimises dimensional changes, protects against tarnish and oxidation, and keeps the natural colours consistent.

For delicate components.

**Metals, Plastics and Wood:** **EUROPASTE 200** steps in with its gentle buffing action, once combined with maizorb produces a high polishing finish. Maizorb is biodegradable and offers a quieter environment, it's also cost-effective for large batches.

**Plastics and Wood:** **EUROPASTE 220** enhances surface smoothness for a delightful touch and removes imperfections like mould lines without dust clouds. And, it's gentle enough for even soft plastics.

**Metals, Plastics and Wood:** **WALNUT PASTE** utilises the power of natural walnut shells to polish various materials. It improves surface texture with a smooth, natural finish and boasts eco-friendly credentials.

SKU	MATERIALS	FUNCTION	VIBRATORY FINISHING PROCESS										
			FERRIOUS	NON FERRIOUS	DEBURR	DESCALE	DEGREASE	POLISH	BURNISH	PROTECTION	SMOOTHING	NEUTRALISE	
EUROPASTE 125	Steel/Stainless Steel	Coarse Grinding/Lapping	✓	✓	✓				✓	✓	✓	✓	
EUROPASTE 150	Brass/Copper/Steel	Fine Lapping		✓					✓			✓	
EUROPASTE 200	Metals/Plastic	Polishing	✓	✓					✓	✓			
EUROPASTE 220	Plastics/Wood	Polishing		✓					✓				
WALNUT PASTE	Metals/Plastic/Wood	Polishing	✓	✓					✓	✓			



25KG CONTAINERS



# CONSUMABLES



# MAIZORB & WALNUT SHELL

## MAIZORB: A SUSTAINABLE AND EFFICIENT DRYING SOLUTION

Maizorb, derived from natural corn cobs, is an eco-friendly and biodegradable drying media that offers exceptional performance. Its high absorbency ensures rapid and efficient moisture removal from various components, making it ideal for drying applications in industries like pharmaceuticals, electronics, and food processing.

### Key Benefits of Maizorb:

- **Exceptional absorbency:** Maizorb can absorb up to four times its weight in moisture, ensuring quick and thorough drying.
- **Sustainable and biodegradable:** Derived from natural corn cobs, Maizorb is an environmentally friendly alternative to synthetic drying media.
- **Gentle and non-abrasive:** Maizorb's soft texture prevents damage to delicate components during the drying process.
- **Reusable and cost-effective:** Maizorb can be reused multiple times, making it a cost-effective drying solution.

MAIZORB	PASS	RETAINED
GM 6 VERY COARSE	5.00MM	3.00MM
GM 12 COARSE	2.00MM	1.50MM
GM 16 MEDIUM	1.50MM	1.10MM
GM 20 FINE	1.10MM	0.75MM
GM 30 VERY FINE	0.75MM	0.60MM

WALNUT SHELL	PASS	RETAINED
GN 7 VERY COARSE	4.50MM	2.50MM
GN 8 VERY COARSE	4.00MM	2.50MM
GN 12 COARSE	1.70MM	1.30MM
GN 16 MEDIUM	1.30MM	0.80MM
GN 20 FINE	1.00MM	0.45MM
GN 30 VERY FINE	0.80MM	0.45MM
GN 80 VERY FINE	0.45MM	0.20MM

**WHY NOT ASK US ABOUT:**

STEEL MEDIA  
WOOD MEDIA  
SHOT BLAST



# CERAMIC MEDIA



Ceramic abrasive media is a hard and durable material used in vibratory finishing processes to deburr, polish, and descale parts. It comes in a variety of shapes, sizes, and cutting capabilities, making it suitable for a wide range of applications.

Ceramic abrasive media is available in a variety of shapes, including:





- **Cylinders:** Cylindrical shape is a popular shape of ceramic abrasive media. It is available in a variety of sizes and can be used for a variety of applications, including deburring, polishing, and radiusing.
- **Tristar:** Ceramic media is another common type of ceramic abrasive media. It is often used for deburring and polishing parts with complex geometries.
- **Ellipses:** Ellipse shaped media is the most common type of ceramic abrasive media. It is available in a variety of sizes and can be used for a variety of applications, including deburring, polishing, and radiusing.
- **Triangles:** Ceramic triangle chips are the most common shape available. It is often used for deburring and descaling parts with heavy contaminants.
- **Arrowheads:** Arrowhead ceramic media is a very aggressive form of ceramic abrasive media. It is often used for descaling parts with heavy rust or scale.



HARDNESS CHART

ABRASIVE GRADE	ABRASIVENESS	COLOUR
BR	Super Cut	Brown
TC12	Fast Cut	L/Brown
TC2	Medium Cut	Grey
TC1	General Purpose Cut	Grey
TC5	General Purpose Cut	Grey
ASR	Fine Cut	Grey
TC9	Ultrafine Cut	Pink

MEDIA IS AVAILABLE IN 25KG AND FOR USE INSIDE OF MACHINERY

		CERAMIC MEDIA SIZE (MM)									
MEDIA SHAPE	SHAPE	3	6	10	12	16	20	25	32	38	50
TRIANGLE		✓	✓	✓	✓	✓	✓	✓	✓	✓	✓
CYLINDER		✓	✓	✓	✓	✓	✓				
ELIPSES				✓				✓			
TRI-STAR			✓	✓			✓				



# PLASTIC MEDIA

Plastic type abrasive media is a versatile material used in vibratory finishing processes to deburr, polish, and descale parts. It comes in a variety of shapes, sizes, and abrasive capabilities, making it suitable for use on a wide range of materials and applications.

Low Density Plastic Type Abrasive Media is available in a variety of shapes, including:

- **Cones:** Cone shaped media is a popular shape of plastic media. It is available in a variety of sizes and can be used for a variety of applications, including deburring, polishing, and radiusing.
- **Tetrahedron:** Plastic media is another common type of abrasive media. It is often used for deburring and polishing parts with complex geometries.
- **Triangles:** Triangular media offers a balance between aggressiveness and gentleness, making it suitable for a wide range of applications.
- **Bowties;** The unique shape effectively rounds off sharp edges and corners, creating a smooth transition between surfaces.
- **Paraboloids:** Paraboloid-shaped media is a specialised type of abrasive media used for precision polishing and finishing.
- **Tri-Star:** The shape provides a balance between aggressiveness and gentleness, making it suitable for a wide range of materials.



25KG BAGS

	ABRASIVE GRADE	ABRASIVENESS	COLOUR
<b>HARDNESS CHART</b>	HI-CUT	Harsh - Rapid Removal	Black
	FC	Medium - Moderate Removal	Yellow
	UF	General Purpose	Pink
	PCH	General Purpose	D/Green
	PH	Fine - Light Removal	Green
	GP	Fine Finishing	D/Green
	PCX	Fine Finishing	Red
	P67	General Purpose	Pink/Blue
	PH1	Fine - Light Removal	Yellow
	PA	Fine Finishing	White

		PLASTIC MEDIA SIZE (MM)											
MEDIA SHAPE	SHAPE	10	12/20	12	15	16/20	20	23	25	30	38	50	60
CONES		✓		✓	✓		✓		✓	✓	✓	✓	✓
TETRAHEDRONS		✓			✓	✓		✓		✓	✓		✓
BOWTIES			✓										
PARABOLOIDS										✓		✓	✓
TRI-STAR									✓				

# PORCELAIN MEDIA



Porcelain media is a non-abrasive material used in vibratory finishing processes to polish parts. It is made of dense, vitreous porcelain that is fired at high temperatures, making it hard and durable. Porcelain media is available in a variety of shapes, sizes, and densities, making it suitable for a wide range of polishing applications.

Low Density Plastic Type Abrasive Media is available in a variety of shapes, including:

- **Spheres:** Spherical porcelain media is a good choice for polishing parts with complex geometries. It is also a good choice for polishing parts that are prone to scratching, as the smooth, rounded edges of the media will not mark the surface of the part.
- **Cylinders:** Cylindrical porcelain media is a popular choice for polishing parts with smooth, even surfaces. It is available in a variety of sizes and can be used for a variety of applications, including polishing jewellery and metal components.
- **Ellipses:** Elliptical shaped media is a good choice for polishing parts with curved surfaces. It is available in a variety of sizes and can be used for a variety of applications, including polishing jewellery, metal components, and plastic parts.
- **Tri-stars:** Tri-Star porcelain media is a good choice for polishing parts with sharp edges. The sharp edges of the media will help to break down and remove burrs and other imperfections from the part.

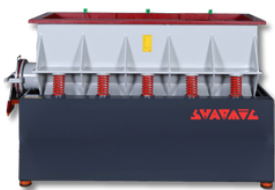

VM TROUGH

## HARDNESS CHART

ABRASIVE GRADE	ABRASIVENESS	COLOUR
TCX	Fine Finishing/Polishing	White
HD	Fine Finishing/Polishing	D/Brown

MEDIA SHAPE	SHAPE	PORCELAIN MEDIA SIZE (MM)							
		3	4	5	6	10	12	16	20
SPHERE		✓	✓	✓					
TRI-STAR					✓				
ELIPSES						✓			
CYLINDER		✓	✓		✓				
TRIANGLE		✓	✓		✓			✓	✓

Note: Various lengths available for cylinder shape media.



# VRX SERIES VIBRATORY SURFACE FINISHING MACHINES



# HIGH PERFORMANCE



## OUR PROMISE, NO EXTRA CHARGE, INCLUDED IN THE PRICE

We thrive for success, which is why we insist on coming to you to train your staff, check the installation, and make sure that the processes are working correctly so you are achieving the desired and approved results. We would not offer you anything without approval.

- You will receive free pre-site visit and installation check.
- You will receive a free component assessment.
- We will develop a process which is then approved by you, which is tailored to your specific needs.
- You will learn how to use the machinery safely and efficiently.
- You will be able to ask questions and get personalised training from our experts.
- We will provide after sales consultancy and future project development support.
- We will provide machinery back up support from our experienced team of engineers.

We believe that our free promises are an essential part of our customer service. It is our way of showing you that we are committed to your success for the long run.

The VRX Series of machines outperform its competitors and is 10% more efficient than the previous VRM machines on the market.

	VRX500
Amplitude	4
Working Angle	60
Cycle Time (sec.)	28
Tumble per Cycle (pcs.)	4
Motor Kw	4
Motor Speed (rpm)	1500

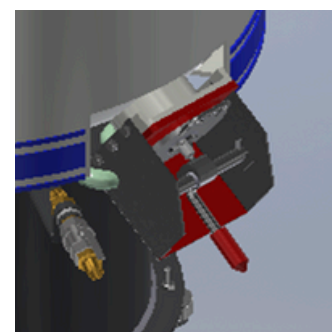

OPTIONAL QUICK  
RELEASE DISCHARGE



FREE ANTI-VIBRATION FEET

# SELF SUFFICIENT

---



Automatic Lubrication Applications

Unlike our competitors the VRX Series have automatic lubrication cartridges that require replacement only once a year.

# LONGER BEARING LIFE

---

Using less weight in our VRX Series machines extends bearing life by 30%, while achieving the required amplitude and kneading angle values for the process.

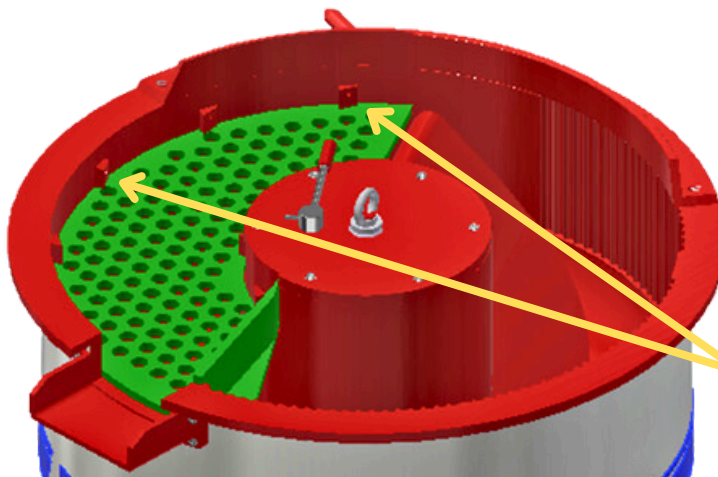

QUICK AND EASY RELEASE FOR  
EASE OF CHANGING SCREEN

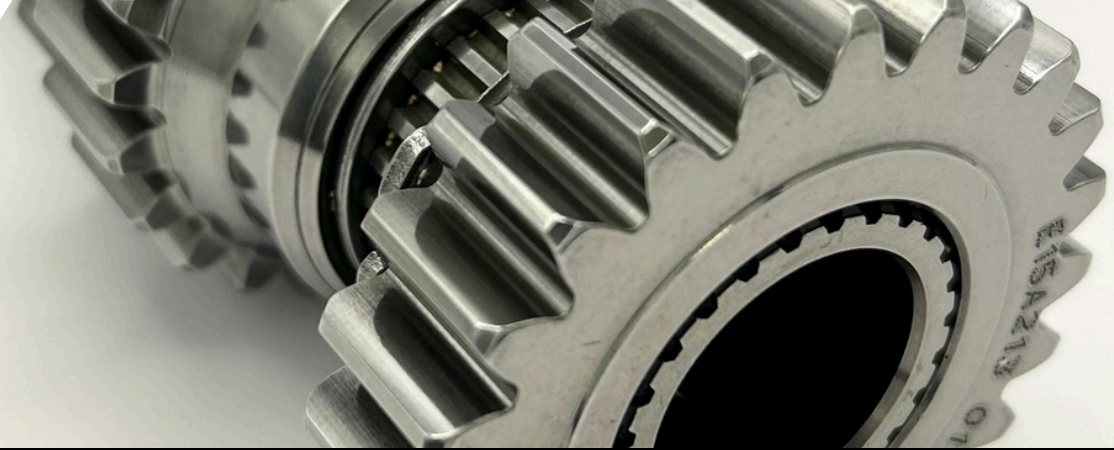

# OPTIMUM BOWL DIMENSIONS



VRX Series machines have been optimised for channel width and depth, resulting in improved performance and efficiency.



We use the best quality of the polyurethane materials from around the world.

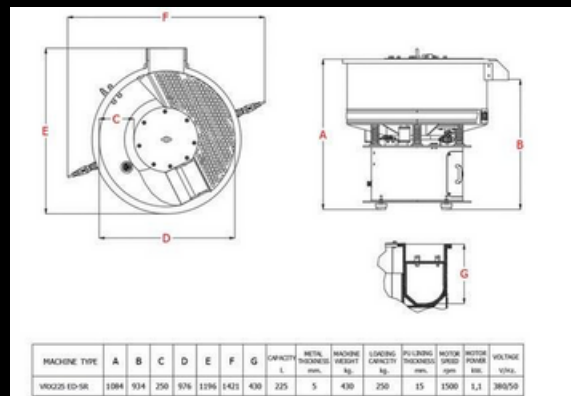

Machine Type	A mm	B mm	C mm	D mm	E mm	F mm	G mm	H mm	Capacity L	PU Thickness mm	Steel Thickness mm	Weight Kg.
VRM2	59	221	-	277	277	251	88	-	2	7	3	11
VRM20	127	438	-	478	530	520	195	-	18	20	-	60
VRM50	150	580	-	680	680	905	220	-	42	30	-	160
VRX125	202.5	790	840	1135	1160	970	328	215	118	20	5	350
VRX225	250	970	935	1310	1210	1080	430	250	228	20	5	465
VRX350	300	1130	1005	1470	1330	1155	425	300	309	20	5	600
VRX500	375	1365	1030	1720	1550	1200	520	380	570	20	5	790
VRX800	430	1520	1125	1805	1685	1295	580	380	836	20	6	1310
VRX1100	480	1640	1275	1910	1815	1470	665	420	1120	20	8	1550
VRX1500	550	1790	1300	2145	2010	1510	668	460	1396	20	8	2140
VRM2000	625	1975	-	2190	2182	1585	683	-	1700	20-30	10	2620
VM3200	834	2325	-	2520	2470	1510	610	-	2400	25-35	10	2900





# OPTIMUM MOTOR POSITIONS

---

The optimum placement of the motor relative to the center of gravity is a critical factor in machine performance. By carefully considering the relationship between these two points, the engineers have designed machines that are more efficient, productive, and reliable.

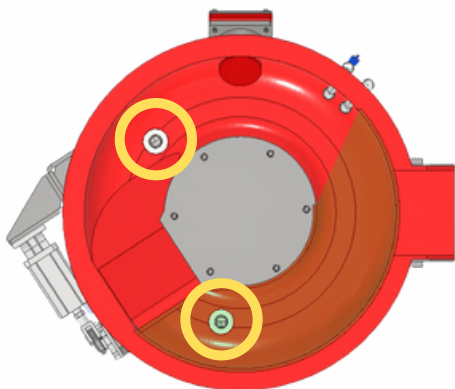
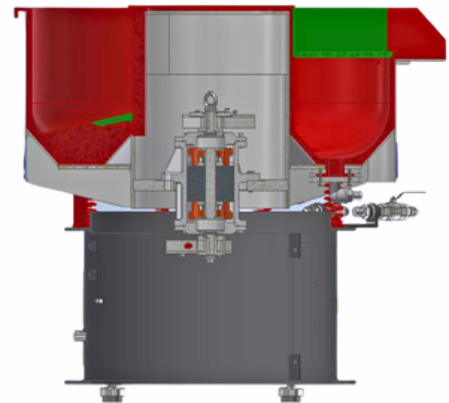

## WATER DRAINAGE FILTERS

---

The VRX125 is the smallest machine in the VRX series, with a volume of 125 litres and two standard filters for quick process water drainage.



# PNEUMATIC TECHNOLOGY

---

**Optional pneumatic controlled auto unload ramps:** The pneumatic controlled auto unload ramps are the most notable addition to the VRX Circular Vibratory Machine Range. This revolutionary feature streamlines the unloading process, eliminating the need for manual labour and minimising the risk of human error.

- Increased Performance
- Free Control Panel
- More Ergonomic
- Increased Spring Axis
- Quick Release Screen
- Optional Pneumatic Unload Ramp
- Cone Lower Bowl
- Unload Screen
- Twin Drain
- 10-15% More Efficient
- Increased Tumbles
- Decreased Lap Time
- Increased Vertical Amplitude
- Mould Improvement
- Free Optional Quick Discharge
- 2 Years Warranty/3500 Hour

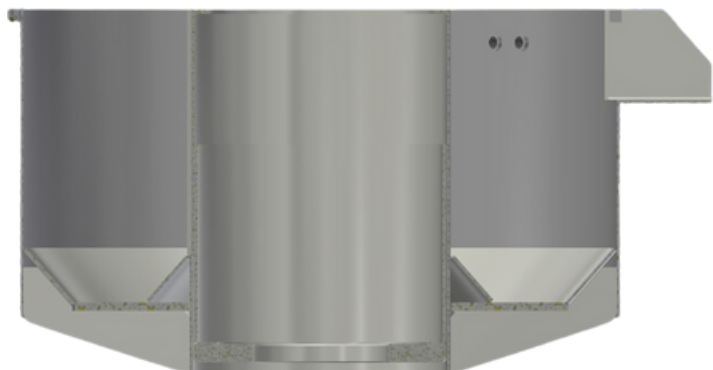



**SM SERIES  
CIRCULAR TYPE  
SURFACE FINISHING  
MACHINES**



**SHARMA**.co.uk

# VIBRATORY FINISHING

EXTENDED  
BASE



The vibratory finishing machine is a versatile manufacturing process used to deburr, polish, burnish, descale, and hone a wide range of workpieces. It is a mass finishing process, meaning that it can process multiple parts simultaneously, making it ideal for high-volume production.

## FEATURES

- EFFECTIVE MOTOR POSITION FOR SUPERIOR VIBRATION.
- HIGH TENSILE NUT BOLTS FOR LONGER MACHINE LIFE.
- EFFICIENT REMOVAL OF PROCESS FLUID FOR BEST SURFACE FINISH.
- ENERGY EFFICIENT MOTOR.
- BOWLS SHOT BLASTED BEFORE AND AFTER POLYURETHANE LINING FOR PAINTING.
- EXTENDED BASES FOR OPERATOR-FRIENDLY OPERATIONS.
- ANTI ROTATION MOTOR LOCKING PLATE PROVIDED.
- BOWLS ARE STRESS RELIEVED
- OPTIONAL REVERSE
- OPTIONAL CONTROL PANELS



## ADVANTAGES

- CAN HANDLE VERY SMALL TO LARGE PARTS. BATCH OR CONTINUOUS OPERATION.
- IN-PROCESS INSPECTION.
- INTEGRAL SEPARATION.
- BETTER MEDIA/PARTS MIXING SINCE IT HAS CASCADE AND CIRCULAR ACTION.
- ECONOMICAL FOR GENERAL PURPOSE WORK, HEAVY DEBURRING AND CONTINUOUS INSPECTION.



# THE SPECIFICATIONS

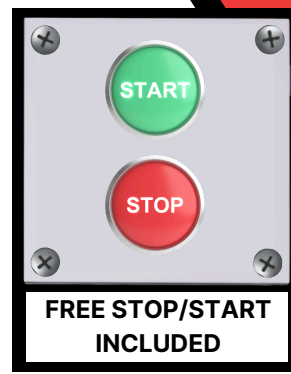

## MACHINE WITHOUT SEPARATION (MANUAL UNLOAD)

Models	Total Volume (ltrs)	O.D. (mm)	Chamber Width (mm)	Media Work Load (kg)
SM1	30	613	204	20-30
SM2	60	710	230	20-60
SM3	90	855	256	30-90
SM4	120	1020	262	40-120
SM5	210	1220	280	50-150
SM10	300	1347	342	100-375
SM20	600	1606	430	200-650
SM40	1200	2010	530	TBC

**SEPARATION SCREEN (AUTO UNLOAD) AVAILABLE**

### OUR PROMISE, NO EXTRA CHARGE, INCLUDED IN THE PRICE.

We thrive for success, which is why we insist on coming to you to train your staff, check the installation, and make sure that the processes are working correctly so you are achieving the desired and approved results. We would not offer you anything without approval.

- You will receive free pre-site visit and installation check.
- You will receive a free component assessment.
- We will develop a process which is then approved by you, which is tailored to your specific needs.
- You will learn how to use the machinery safely and efficiently.
- You will be able to ask questions and get personalised training from our experts.
- We will provide after sales consultancy and future project development support.
- We will provide machinery back up support from our experienced team of engineers.

We believe that our free promises are an essential part of our customer service. It is our way of showing you that we are committed to your success for the long run.

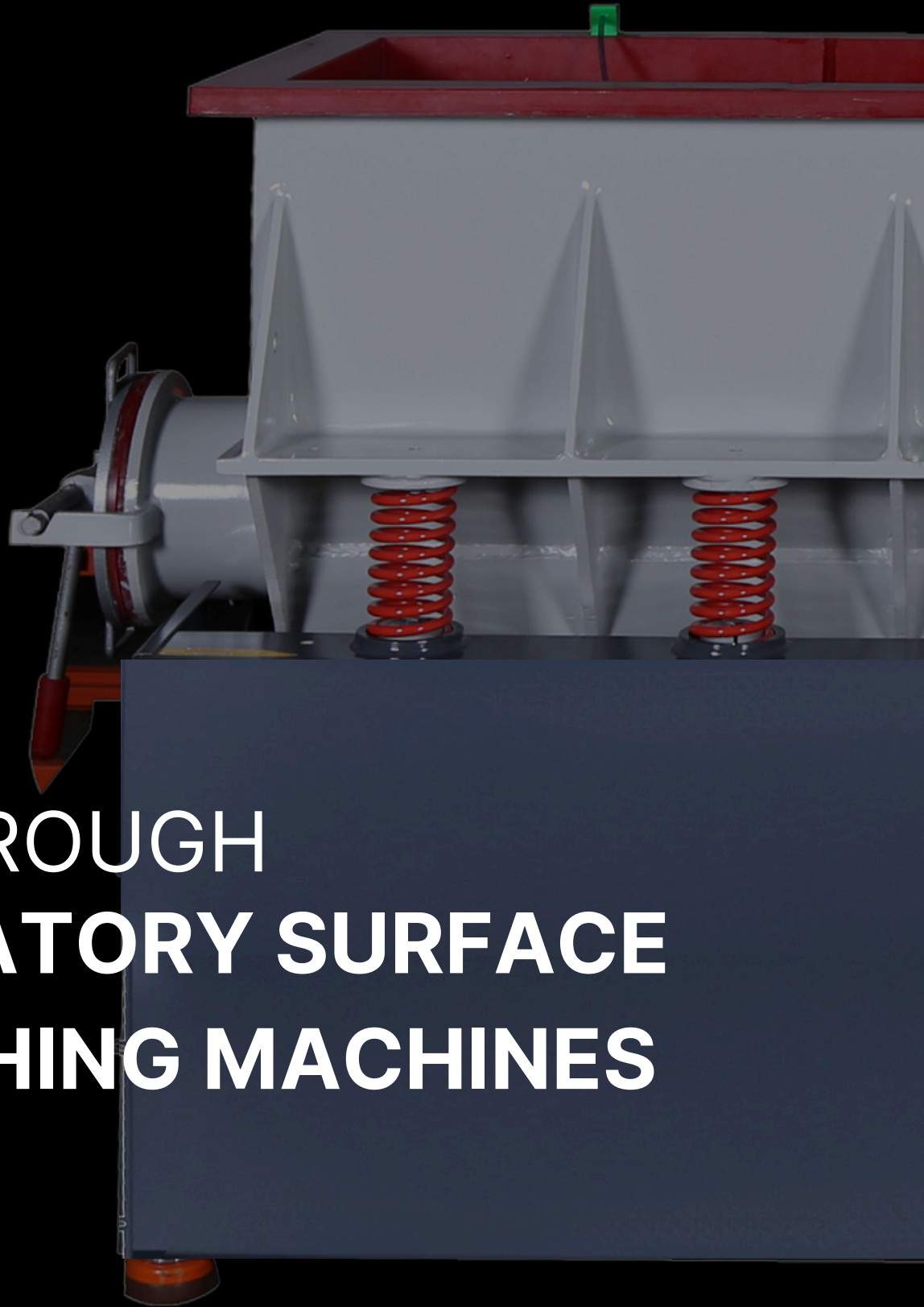

# VM TROUGH VIBRATORY SURFACE FINISHING MACHINES



# HIGH PERFORMANCE

## OUR PROMISE, NO EXTRA CHARGE, INCLUDED IN THE PRICE.

We thrive for success, which is why we insist on coming to you to train your staff, check the installation, and make sure that the processes are working correctly so you are achieving the desired and approved results. We would not offer you anything without approval.

- You will receive free pre-site visit and installation check.
- You will receive a free component assessment.
- We will develop a process which is then approved by you, which is tailored to your specific needs.
- You will learn how to use the machinery safely and efficiently.
- You will be able to ask questions and get personalised training from our experts.
- We will provide after sales consultancy and future project development support.
- We will provide machinery back up support from our experienced team of engineers.

We believe that our free promises are an essential part of our customer service. It is our way of showing you that we are committed to your success for the long run.

Through vibratory surface finishing machines are ideal for the surface finishing of heavy, large, long or sensitive parts in terms of unlimited application possibilities.



HEAVY DUTY SPRINGS



ANTI-VIBRATION FEET



QUICK RELEASE DISCHARGE

# MAKE LIFE EASIER

---

Trough type finishing machines are produced in standard sizes from 19 litres up to 2200 litres and dimensionally will allow parts up to 2000mm long to be processed

They can be employed with plastic or ceramic medias for standard finishing and porcelain for polishing. There are also versions available for use with stainless steel media for burnishing.

The trough type machines can also be supplied with dividers, thus allowing parts to be processed singularly to avoid damage or to accommodate multistage finishing with different medias.

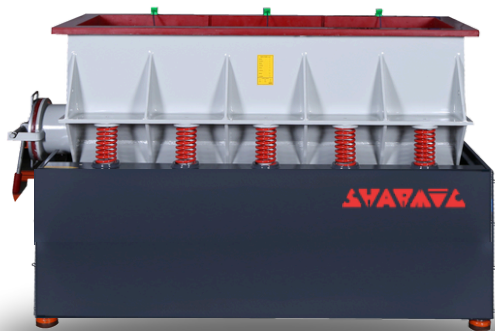

## FIXED SEPARATORS

---



THE PROCESS BOWL CAN BE ADJUSTED OR DIVIDED INTO INDEPENDENT SECTIONS WITH FIXED SEPARATORS. THIS FEATURE IS VERY USEFUL WHEN SENSITIVE PARTS ARE DESIRED TO BE TREATED WITHOUT TOUCHING EACH OTHER OR WHEN A DIFFERENT PROCESS MATERIAL IS USED FOR A SEPARATE PROCESS IN EACH SECTION.



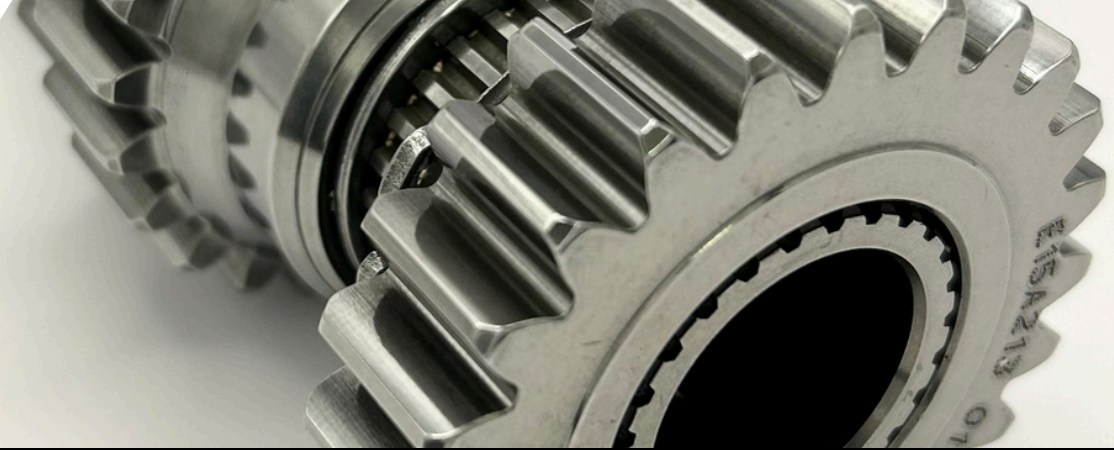

# OPTIMUM DIMENSIONS

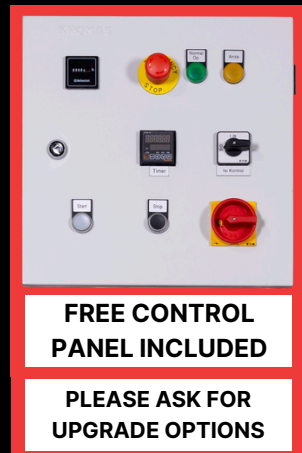

Drive motors are mounted under the machine, directly under the process bowl. In addition, larger capacity machines have two synchronous drive motors mounted on the sides of the bowl. Motors and weights are combined with unique vibration-absorbing couplings.

Machine Type	A mm	B mm	C mm	D mm	E mm	F mm	Capacity L.	PU Thickness mm	Weight Kg.	Motor Cycle rpm.	Motor Power kW.
VM20Y	170	530	425	710	540	235	20	15	125	1500	0.75
VM20 Y GR	170	530	600	1600	782	235	20	15	200	1500	0.75
VM35Y	220	590	360	635	620	305	35	15	160	3000	0.65
VM70Y	300	750	430	795	670	356	70	20	355	3000	2
VM150Y	365	870	715	1200	1070	490	150	20	496	1500	1,1/1,5
VM375 Y	500	1500	1190	1800	1120	570	375	20	1270	1500	4/6
VMY2200	1100	2200	1320	3900	1685	967	2200	25-35	4310	1500	15x2
VMY2200 L	1300	2200	1520	3900	1685	967	2500	25-35	4525	1500	15x2
VMY2400	1510	1600	1900	3242	2090	1370	2400	25-50	4545	1500	15x2

Technical Drawing

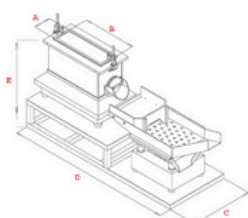

VM 20 Y GR

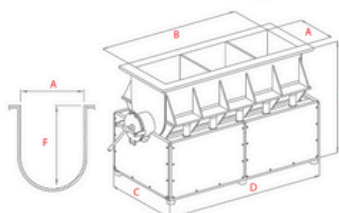

VM 20 / 150 / 375 Y

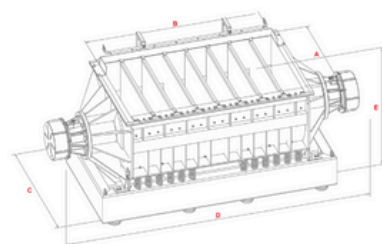

VM Y 2200



# ACOUSTIC NOISE COVERS

---

- REDUCE ACOUSTIC NOISE LEVELS
- AVAILABLE IN ECO AND PREMIUM VERSIONS
- CUSTOM BUILT
- HEAVY DUTY
- SOUND PROOFING
- PNEUMATIC OR MANUAL CONTROL AVAILABLE
- FREE STANDING OR ATTACHED
- IMPROVE EMPLOYEE HEALTH
- REDUCE EMPLOYEE ABSENTEEISM





**SINGLE PHASE  
TUMBLING SURFACE  
FINISHING MACHINES**





# VIBRATORY FINISHING MACHINES



The VA series of vibratory finishing machines from Sharmic Engineering is ideal for small batches of small components. These machines are available in three sizes: VA25, VA40, and VA75. The VA25 and VA40 machines are ball burnishing models, while the VA75 machine is a standard model.

All VA series machines come complete with an outlet and lid. The VA\*\*/SS model for the VA25, VA40 and VA75 machines also includes a discharge door. The VA\*\*/TD model for the VA40 and VA75 machines includes a tilting device for the bowl.



**SINGLE PHASE**

## PROCESSES:

- Radiusing
- Deburring
- Degreasing
- Descaling
- Polishing
- Protection
- Smoothing
- Cleaning

## INDUSTRIES:

- Automotive
- Aerospace
- Medical
- Jewellery
- Electronics
- Plastics
- Defence
- Additive Manufacturing

## BENEFITS:

- Batch Processing
- Reduced Labour Costs
- Versatility
- Uniformity
- Precise Control
- Reduced Processing Time
- 1.4L - 21L Capacity
- From The USA

## EASY UNLOAD AVAILABLE



Model	Diameter (Inches)	Bowl Width (Inches)Ⓢ	Bowl Depth (Inches)	Capacity (Litre)
TV5	8	4	3.75	1.4
TV10	10	3.5	5	2.8
VA18	12	4	4.25	5.06
VA25	14	3.5	5.75	6.15
VA40	17	4.25	7	9.8
VA75	21	7	9.5	21

The image shows three barrel surface finishing machines, arranged in a row. Each machine is a light-colored, oval-shaped barrel with a red border. A blue strap is attached to each barrel, secured with a metal clamp. The central machine has a metal ring and a metal clamp attached to its blue strap. The text "ROTA SERIES BARREL SURFACE FINISHING MACHINES" is overlaid in white, bold, sans-serif font across the middle of the image.

**ROTA SERIES  
BARREL SURFACE  
FINISHING MACHINES**



# HEAVY DUTY

---

MADE IN GREAT BRITAIN

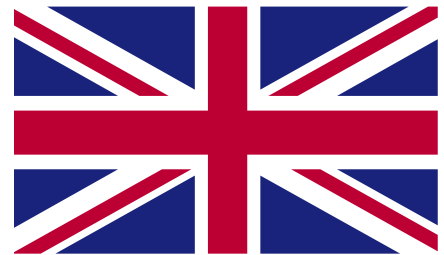

Barrel burnishing, or tumbling, is a proven and cost-effective technique for finishing small components to a high standard. By combining water with abrasives or polishes, barrel burnishing can significantly improve the surface finish of components. Simply changing the media allows barrel burnishing to be used for a variety of tasks, such as removing surface blemishes, smoothing sharp edges, and polishing surfaces. This process is effective on a wide range of materials, including soft and hard metals, ceramics, and plastics.

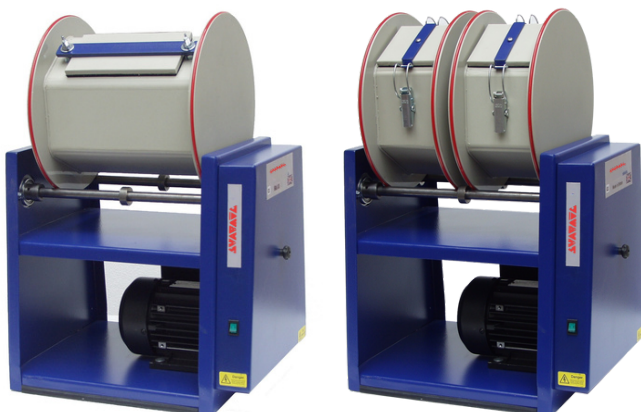

**MIX & MATCH**  
3LITRE AND 6LITRE CAPACITY

- MADE FROM POLYPROPYLENE
- NEW POWER TRANSMISSION SYSTEM
- QUICK RELEASE LID
- MIX BETWEEN 3L AND 6L BARRELS
- CHOOSE FROM 3L UP TO 18L CAPACITY
- MADE IN BRITAIN
- USED FOR GRINDING
- USED FOR POLISHING
- USED FOR DEBURRING
- PROCESS METALS
- PROCESS PLASTICS
- PROCESS WOOD

# THE SPECIFICATIONS



**WE'RE COMMITTED TO GETTING IT RIGHT EVERY SINGLE TIME, THAT'S WHY WE ASK FOR SAMPLE PARTS TO APPROVE A PROCESS WE KNOW WORKS SO THAT WE CAN GET YOUR APPROVAL AND SUGGEST THE BEST EQUIPMENT TO GET YOU GOING, FREE OF CHARGE.**

ROTABARREL 6 LITRE model, part no 4484E, Size 40 x 30 x 57 cm high 18Kg, 1.9A, 220/240 volts ac.

Supplied with 1 x 6 litre barrel body as standard.

ROTABARREL 2 x 3 LITRE model, part no 4502D, Size 40 x 30 x 57 cm high 18Kg, 1.9A, 220/240 volts ac.

Supplied with 2 x 3 litre barrel body as standard.

ROTABARREL 12 LITRE model, part no 3486D, Size 65 x 30 x 57 cm high 22Kg, 2.1A, 220/240 volts ac.

Supplied with 2 x 6 litre barrel bodies as standard.

ROTABARREL 18 LITRE model, part no 3485D, Size 94 x 30 x 57 cm high 26Kg, 2.4A, 220/240 volts ac.

Supplied with 3 x 6 litre barrel bodies as standard.

**VARIABLE SPEED MOTORS ARE AVAILABLE WITH INVERTER CONTROL (RECOMMENDED FOR DELICATE ARTICLES)**





# SM SERIES CENTRIFUGAL FINISHING MACHINES



# CENTRIFUGAL SURFACE FINISHING

## OUR PROMISE, NO EXTRA CHARGE, INCLUDED IN THE PRICE.

We thrive for success, which is why we insist on coming to you to train your staff, check the installation, and make sure that the processes are working correctly so you are achieving the desired and approved results. We would not offer you anything without approval.

- You will receive free pre-site visit and installation check.
- You will receive a free component assessment.
- We will develop a process which is then approved by you, which is tailored to your specific needs.
- You will learn how to use the machinery safely and efficiently.
- You will be able to ask questions and get personalised training from our experts.
- We will provide after sales consultancy and future project development support.
- We will provide machinery back up support from our experienced team of engineers.

We believe that our free promises are an essential part of our customer service. It is our way of showing you that we are committed to your success for the long run.

## WET & DRY

### PROCESSES:

- Radiusing
- Deburring
- Degreasing
- Burnishing
- Descaling
- Polishing
- Protection
- Smoothing
- Superfinishing

### INDUSTRIES:

- Automotive
- Aerospace
- Medical
- Jewellery
- Electronics
- Plastics
- Optics
- Defence
- Additive Manufacturing

### BENEFITS:

- High-Energy Process
- Batch Processing
- Reduced Labour Costs
- Versatility
- Uniformity
- Precise Control
- Reduced Processing Time
- Reduced Water/Compound
- Variable Speed

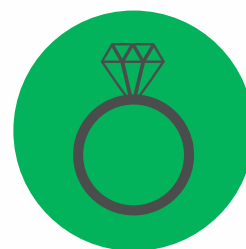
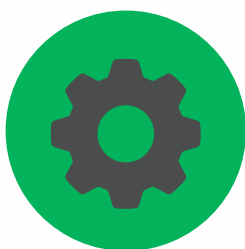



OPTIONAL NOISE COVER



# Take your Finish to the Next Level

Automatic Unload Capability:

01

10 times faster processing time.

02

Rotary base and the process chamber walls are fixed.

03

Easily transferred from the chamber to the vibratory separator.

04

Automatic feedback systems and the next process starts.

# ENHANCED PRODUCTIVITY



The SM Series machines feature a unique rotary base process chamber and fixed chamber walls. After each cycle, the entire chamber tilts to an angle of 140 degrees, effortlessly transferring the processed material to the VE series vibratory separator. This innovative design eliminates cumbersome manual handling, maximising productivity and minimising downtime.

Machine Type	SM7	SM14	SM14 (twin)	SM14 (trebble)	SM20	SM50	SM100	SM200
Capacity (L)	7	14	2 x 14	3 x 14	20	50	100	200
Polyurethane Thickness (mm)	20	20	20	20	20	20	20	20
Process Area Width (mm)	210	280	2 x 280	3 x 280	300	425	585	720
Length (mm)	605	665	665	665	745	1105	1350	1700
Width (mm)	425	465	930	1395	525	950	1380	1655
Height (mm)	1210	1260	1260	1260	1310	1530	1460	1935
Weight (kg)	65	100	200	300	100	303	790	970
Motor Power (kW)	0,37	1,1	2 x 1,1	3 x 1,1	0,75	3	4	10

FILL  
WITH  
MEDIA

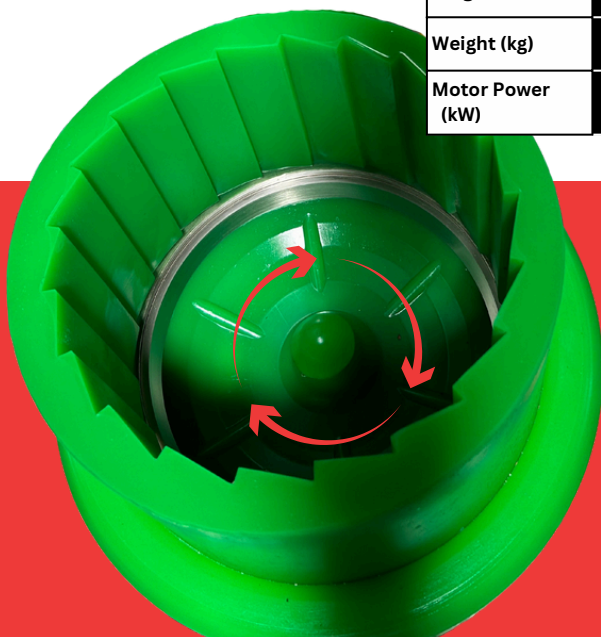

Our machines harness the power of centrifugal force to deliver exceptional results, outperforming traditional vibratory surface finishing techniques by a remarkable ten times faster processing time.

## FOR A FREE ANALYSIS

Sharmic Engineering, Baldwin Road, Stourport-On-Severn,  
Worcestershire, DY13 9AX



TAILORED TO SUIT YOU



# ROTARY BARREL SURFACE FINISHING MACHINES

# CENTRIFUGAL TILTING TUMBLERS

## OUR PROMISE, NO EXTRA CHARGE, INCLUDED IN THE PRICE.

We thrive for success, which is why we insist on coming to you to train your staff, check the installation, and make sure that the processes are working correctly so you are achieving the desired and approved results. We would not offer you anything without approval.

- You will receive free pre-site visit and installation check.
- You will receive a free component assessment.
- We will develop a process which is then approved by you, which is tailored to your specific needs.
- You will learn how to use the machinery safely and efficiently.
- You will be able to ask questions and get personalised training from our experts.
- We will provide after sales consultancy and future project development support.
- We will provide machinery back up support from our experienced team of engineers.

We believe that our free promises are an essential part of our customer service. It is our way of showing you that we are committed to your success for the long run.

Tilting Rotary Barrels work on a cascading action as opposed to toroidal action of a vibratory finishing machine. These machines are ideal for flat, delicate and small components. The cascading action allows the component to tumble more gently, thus reducing the risk of component damage. As optional extras they can have variable speed control and single speed drive for ease of unloading components when tilted.



120L & 330L  
CAPACITY

### PROCESSES:

- Radiusing
- Deburring
- Degreasing
- Descaling
- Polishing
- Protection
- Smoothing
- Superfinishing
- Cleaning

### INDUSTRIES:

- Automotive
- Aerospace
- Medical
- Jewellery
- Electronics
- Plastics
- Optics
- Defence
- Additive Manufacturing

### BENEFITS:

- High-Energy Process
- Batch Processing
- Reduced Labour Costs
- Versatility
- Uniformity
- Precise Control
- Reduced Processing Time
- Less Material Waste
- Variable Speed

For separation of components from media an external vibrating separation service can be considered such as the VE50/VE75.

# ENHANCED PRODUCTIVITY



MEDIA

- **Fast and efficient:** Tilting tumblers with centrifugal systems can produce high-quality finishes quickly and efficiently.
- **Even treatment:** The motorised overturning system ensures that all parts are evenly treated.
- **High precision:** Tilting tumblers with centrifugal systems can be used to achieve a high degree of precision in the finishing process.
- **Versatile:** Tilting tumblers with centrifugal systems can be used for a variety of metal and plastic finishing operations.

- **Deburring:** Remove burrs and other sharp edges from metal and plastic parts.
- **Polishing:** Produce a smooth and shiny finish on metal and plastic parts.
- **Cleaning:** Remove dirt, grease, and other contaminants from metal and plastic parts.

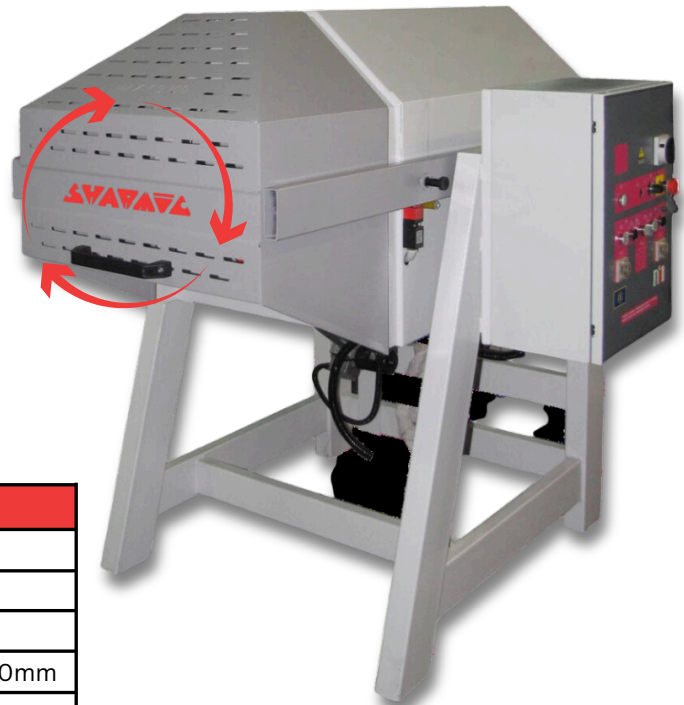

	120L	330L
<b>Power</b>	660W	1119W
<b>Voltage</b>	400 V	400 V
<b>Frequency</b>	50 / 60 Hz	50 / 60 Hz
<b>Dimensions</b>	1400x740x1250mm	1650x1120x1580mm
<b>Weight</b>	350kg	500kg

## FOR A FREE ANALYSIS

Sharmic Engineering, Baldwin Road, Stourport-On-Severn,  
Worcestershire, DY13 9AX



TAILORED TO SUIT YOU

# VRK SERIES CIRCULAR VIBRATORY DRYING MACHINES

# DRYING TECHNOLOGY

Vibratory dryers use natural granular media to dry parts after the surface finishing process. Round vibratory dryers are continuously loaded with wet parts and preheated granules (maizorb). The granules absorb all the moisture from the parts, which are then automatically sifted and discharged from the machine as 100% dry.

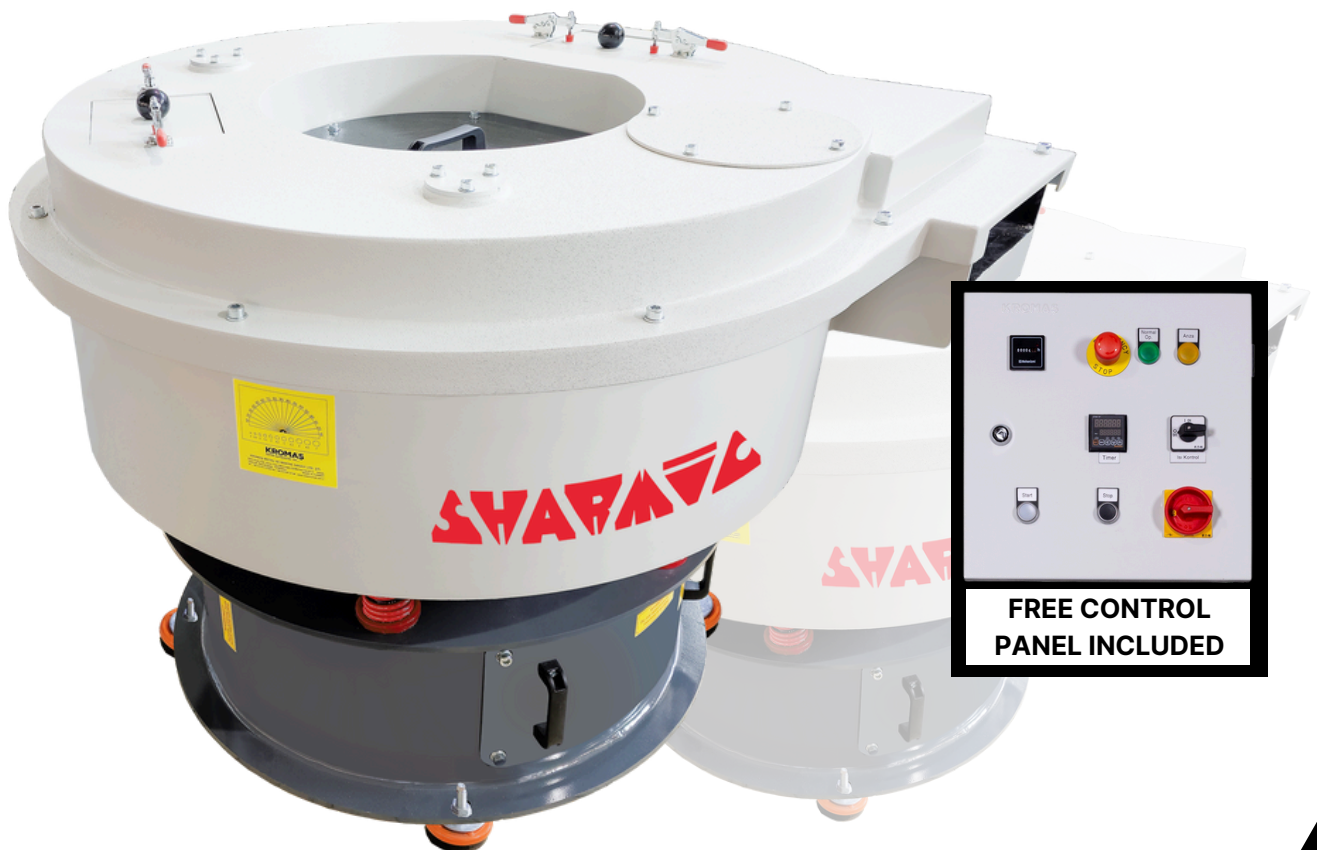



# SELF SUFFICIENT

---



Automatic Lubrication Applications

Unlike our competitors the VRX Series have automatic lubrication cartridges that require replacement only once a year.

The optimum placement of the motor relative to the centre of gravity is a critical factor in machine performance. By carefully considering the relationship between these two points, the engineers have designed machines that are more efficient, productive, and reliable.



## LONGER BEARING LIFE

---

Using less weight in our VRK Series extends bearing life by 30%, while achieving the required amplitude and kneading angle values for the process.

# OPTIMUM BOWL DIMENSIONS

VRK Series machines have been optimised for channel width and depth, resulting in improved performance and efficiency.

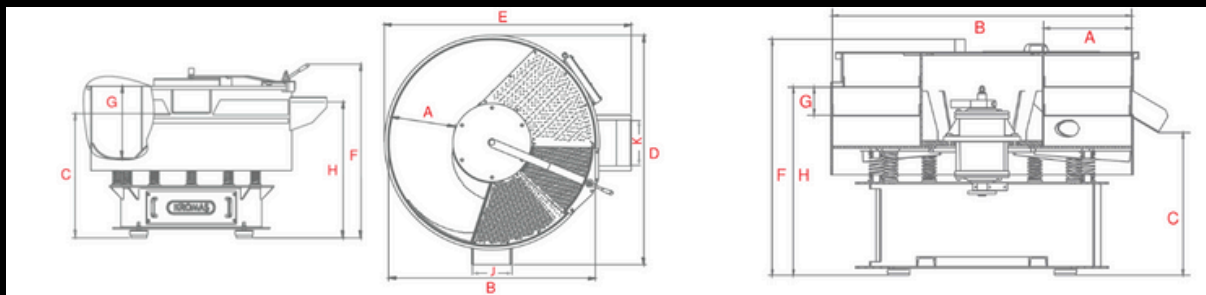

WE USE THE BEST QUALITY OF THE POLYURETHANE MATERIALS FROM AROUND THE WORLD.

Machine Input Height		VRK125 K	VRK225 K	VRK350 K	VRK500 K	VRK800 K	VRK1100 K			
Capacity	Litre	125	225	350	500	800	1100			
PU Thickness	mm	PU SPRAY	PU SPRAY	PU SPRAY	PU SPRAY	PU SPRAY	PU SPRAY			
Steel Thickness	mm	5	5	5	5	6	6			
Process Area Width	mm	A	255	295	345	380	450	490	Process Area Width	A
Inner Diameter	mm	B	990	1130	1290	1510	1750	1890	Inner Diameter	B
Discharge Height	mm	C	751	851	931	1005	1161	1261	Discharge Height	C
Width	mm	D	1125	1220	1400	1620	1865	2002	Width	D
Length	mm	E	1230	1395	1585	1800	2055	2205	Length	E
Height	mm	F	860	970	1080	1170	1370	1470	Height	F
Process Area Height	mm	G	335	409	474	534	632	672	Process Area Height	G
Machine Input Height	mm	H	835	945	1020	1050	1205	1305	Machine Input Height	H
Outlet Chute	mm	J	275	320	385	420	495	565	Outlet Chute	J
Inlet Chute	mm	K	300	350	370	440	500	600	Inlet Chute	K
Weight	Kg		385	500	675	902	1540	1910		
Motor Cycle	rpm		1500	1500	1500	1500	1500	1500		
Motor Power	kW		1.1	2.2	2.2	4	4/6	4/6		
Heater Power	kW		1.8	3	4	4.5	6	6		



# PNEUMATIC TECHNOLOGY

---

Optional pneumatic controlled auto unload: The pneumatic controlled auto unload is the most notable addition to the VRK Circular Vibratory Machine Range. This revolutionary feature streamlines the unloading process, eliminating the need for manual labour and minimising the risk of human error.

- Increased Performance
- More Ergonomic
- Free Control Panel
- Increased Spring Axis
- Optional Pneumatic Unload
- Unload Screen
- 10-15% More Efficient
- Increased Tumbles
- Decreased Lap Time
- Increased Vertical Amplitude
- 2 Years Warranty/3500 Hour



**SHARMIC ENGINEERING LIMITED**

SURFACE FINISHING EQUIPMENT & CONSUMABLES



# CENTRIFUGAL DRYING & DEGREASING MACHINES

# CENTRIFUGAL DRYING & DEGREASING



## OUR PROMISE, NO EXTRA CHARGE, INCLUDED IN THE PRICE.

We thrive for success, which is why we insist on coming to you to train your staff, check the installation, and make sure that the processes are working correctly so you are achieving the desired and approved results. We would not offer you anything without approval.

- You will receive free pre-site visit and installation check.
- You will receive a free component assessment.
- We will develop a process which is then approved by you, which is tailored to your specific needs.
- You will learn how to use the machinery safely and efficiently.
- You will be able to ask questions and get personalised training from our experts.
- We will provide after sales consultancy and future project development support.
- We will provide machinery back up support from our experienced team of engineers.

We believe that our free promises are an essential part of our customer service. It is our way of showing you that we are committed to your success for the long run.

Our tilting centrifugal dryers are ideal for drying metal and plastic articles that are not excessively delicate and do not require pickling or polishing. They are robust yet easy to use, with innovative features such as a lever-operated unloading and tilting system. The fixed basket is made of drilled AISI 304 stainless steels with a hole diameter of 2 mm (0.9 mm available on request). The control panel features a cycle timer, centrifugation switch, and heating switch.

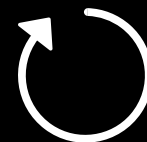

COMPONENTS SPIN  
DRY WITH FORCED  
WARM AIR.

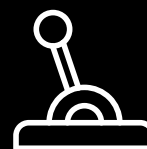

UNLOADING AND  
TILTING ACTION  
THROUGH A LEVER.



DRY METAL AND  
PLASTIC

# DRYING & DEGREASING

FIXED BASKET



SK25

## INDUSTRIES:

- Automotive
- Aerospace
- Medical
- Jewellery
- Electronics
- Plastics
- Optics
- Defence
- Additive Manufacturing



## BENEFITS:

- High-Energy Process
- Control Panel
- Cycle Timer
- Centrifugation Switch
- Batch Processing
- Reduced Labour Costs
- Heating Switch
- Precise Control
- Reduced Processing Time

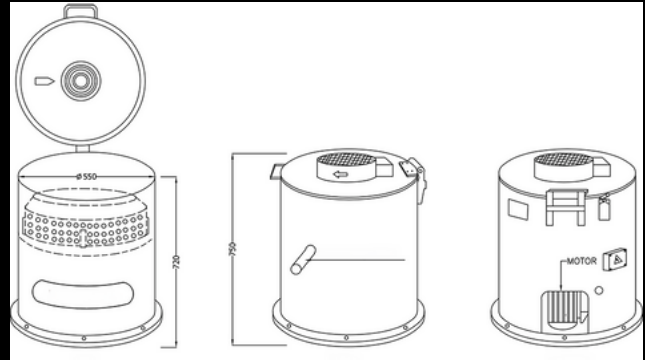

	SK25 Y	SK50 Y	SK25 K	SK50 K
Capacity (kg)	33	46	33	46
Basket Inner Diameter (mm)	420	470	420	470
Width (mm)	645	710	645	710
Length (mm)	750	835	750	835
Height (mm)	685	835	765	835
Centrifugal Cycle (RPM)	600	600	500	500
Motor Power (kW)	0,55	0,55	0,55	0,55
Motor Cycle at 50 Hz (RPM)	1500	1500	1500	1500
Heating Power (kW)	-	-	2	2
Total Power (kW)	0,55	0,55	2,55	2,55
Weight	133	150	138	155

	ASC 50/LR	ASC 70/LR
Internal basket Dimensions (mm)	25	50
Theoretical Volume (litres)	415	445
Capacity (kg)	200	200
RPM	360	370
Heating Elements (W)	645	710
Motor Power (W)	650	720
Total Installed Power (W)	920	985
Overall Dimensions (mm)	140	160
Unloading Opening (mm)	1500	1500
Weight (kg)	480	480



ASC 50/LR

IF YOU ARE LOOKING FOR A RELIABLE AND EFFICIENT WAY TO DRY METAL AND PLASTIC COMPONENTS, OUR TILTING CENTRIFUGAL DRYERS ARE THE PERFECT SOLUTION FOR YOU.

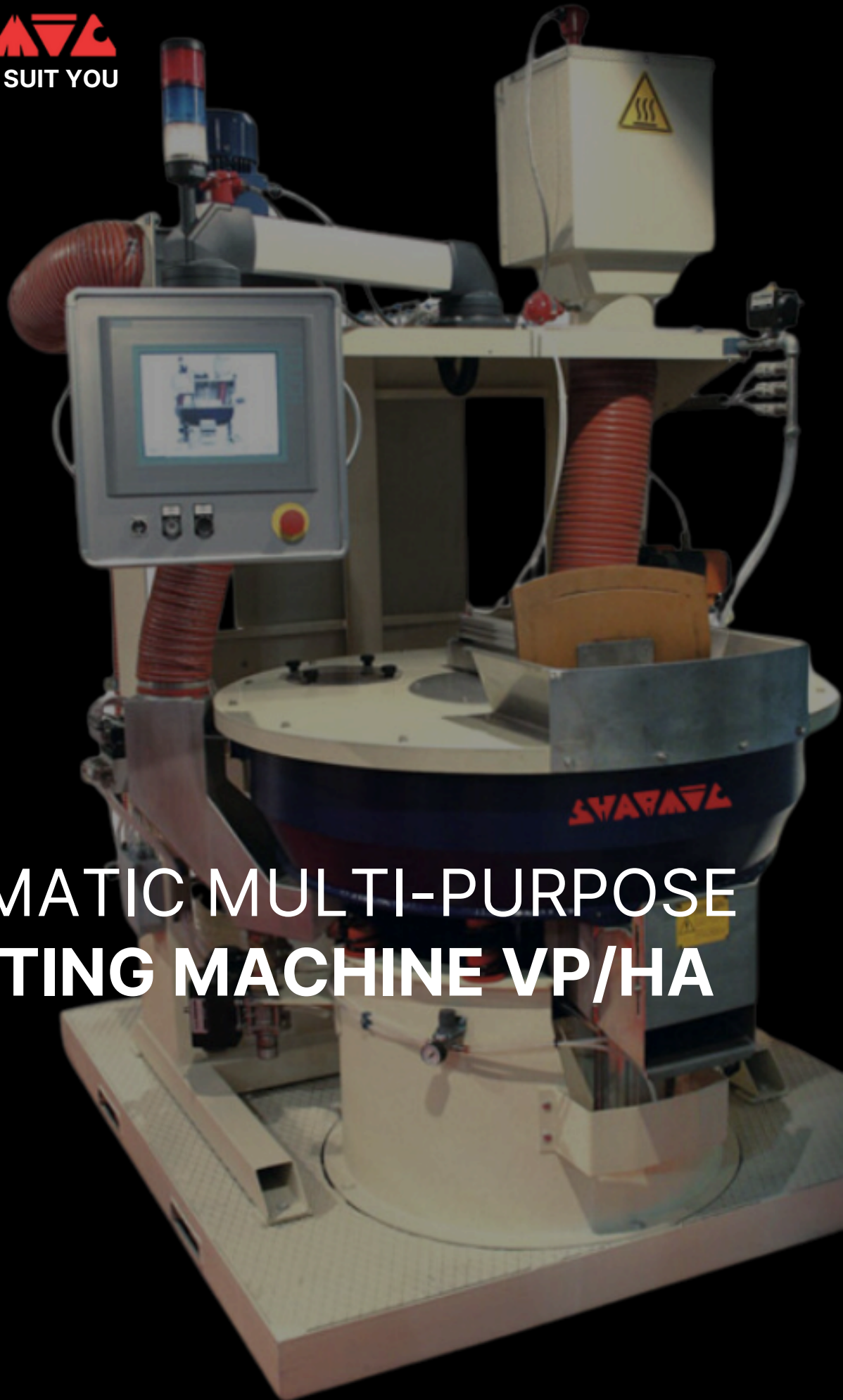

# AUTOMATIC MULTI-PURPOSE VIBRATING MACHINE VP/HA

# AUTOMATIC MULTI-PURPOSE VP/HA

## OUR PROMISE, NO EXTRA CHARGE, INCLUDED IN THE PRICE.

We thrive for success, which is why we insist on coming to you to train your staff, check the installation, and make sure that the processes are working correctly so you are achieving the desired and approved results. We would not offer you anything without approval.

- You will receive free pre-site visit and installation check.
- You will receive a free component assessment.
- We will develop a process which is then approved by you, which is tailored to your specific needs.
- You will learn how to use the machinery safely and efficiently.
- You will be able to ask questions and get personalised training from our experts.
- We will provide after sales consultancy and future project development support.
- We will provide machinery back up support from our experienced team of engineers.

We believe that our free promises are an essential part of our customer service. It is our way of showing you that we are committed to your success for the long run.



The Automatic Multi-Purpose Vibrating Machine VP/HA from Sharmic Engineering is a revolutionary machine that can perform all routine finishing operations on small metal parts, including greasing, deburring, polishing, and drying, consecutively or alternatively in fully automatic mode.

### PROCESSES:

- Radiusing
- Deburring
- Degreasing
- Descaling
- Polishing
- Protection
- Smoothing
- Superfinishing
- Cleaning

### INDUSTRIES:

- Automotive
- Aerospace
- Medical
- Jewellery
- Electronics
- Plastics
- Optics
- Defence
- Additive Manufacturing

### BENEFITS:

- High-Energy Process
- Batch Processing
- Reduced Labour Costs
- Versatility
- Uniformity
- Precise Control
- Reduced Processing Time
- Less Material Waste
- Variable Speed



# ENHANCED PRODUCTIVITY

- Single workstation for all routine finishing operations.
- Fully automatic mode.
- Hot air-drying system for even drying of complex details.
- Can be used on its own, in line with other manufacturing machines, or as a modular, multi-unit finishing plant.



## How it works:

The VP/HA machine is especially designed for part on part processing where there is no need for media, as the surface finish is achieved by the action of the components working against each other in the machine. They can perform processes such as Deburring, Edge Breaking, Cleaning, Degreasing, Polishing and Hot Air Drying in one unit. Components are loaded into the bowl chamber where water and chemical compounds are added to the working chamber via a PLC control unit. The machine performs the process cycle with automatic rinsing, drying in the same chamber before discharged. The machine is capable of a standalone unit or larger system.

	Capacity dm3	Engine Kw	Dimensions mm
VP/HA 10	10	0,35	490x800x120
VP/HA 40	38	0,55	670x800x160
VP/HA 60	60	0,73	930x900x225
VP/HA 150	150	1,5	1140x1000x270
VP/HA 270	270	2,5	1380x1100x320
VP/HA 380	380	3,5	1560x1250x360

**START TO  
FINISH IN ONE  
MACHINE**



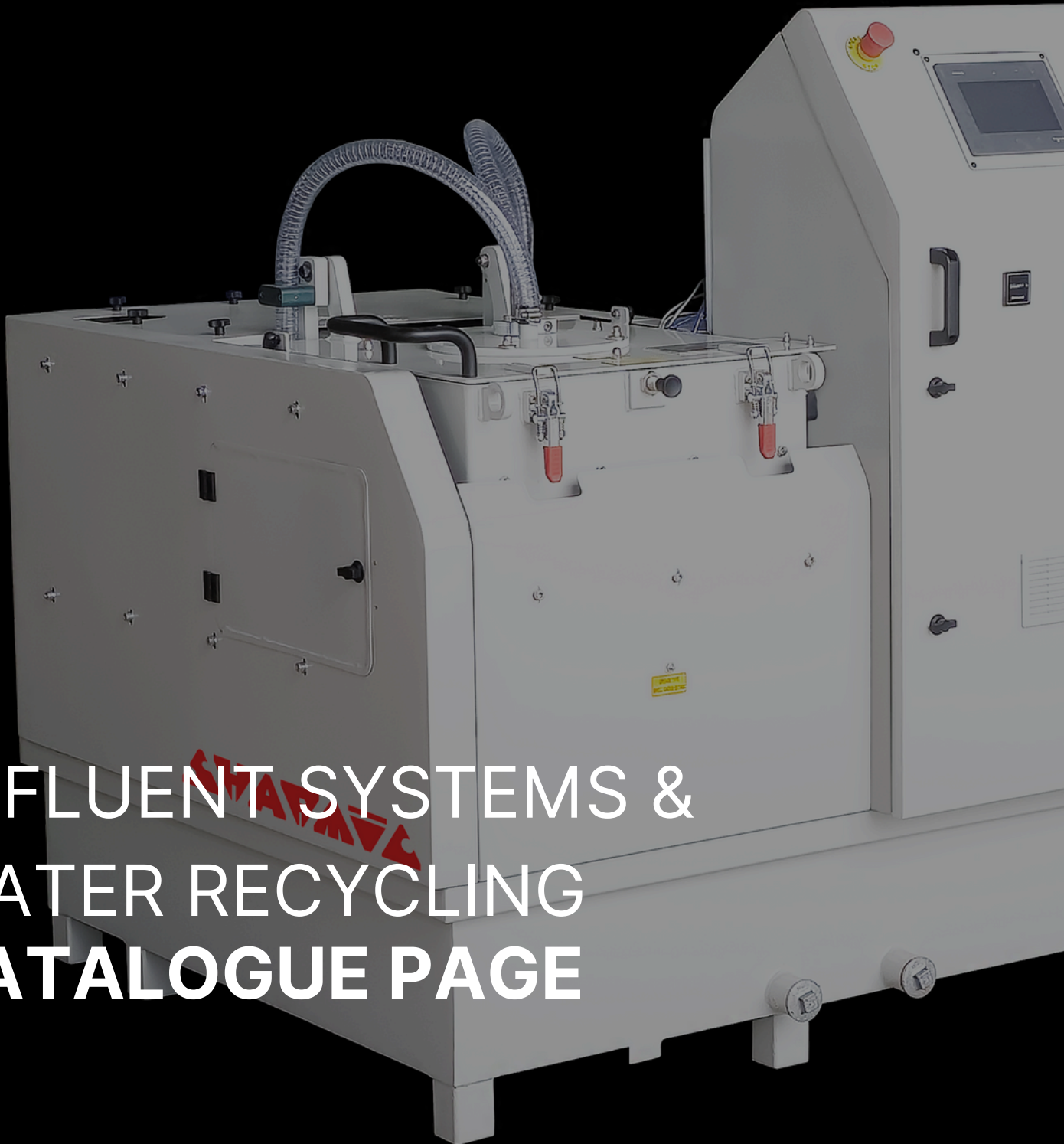

# EFFLUENT SYSTEMS & WATER RECYCLING CATALOGUE PAGE

# PROCESS WATER RECYCLING SYSTEMS

Paper band filters are a type of filtration system that is specifically designed to remove contaminants from the effluent discharged from vibratory finishing machines. They are manufactured in various sizes to suit a corresponding discharge rate, and they can be made from either carbon or stainless steel.

## BENEFITS:

Water treatment offers a number of benefits, including:

- Excellent filtration efficiency: Paper band filters can remove contaminants down to an exceptionally fine level, typically 10-50 microns.
- Continuous filtration: Paper band filters can operate continuously without the need for manual intervention.
- Compact design: Paper band filters are relatively compact, which makes them ideal for use in tight spaces.
- Durable construction: Paper band filters are made from high-quality materials, making them durable and reliable.

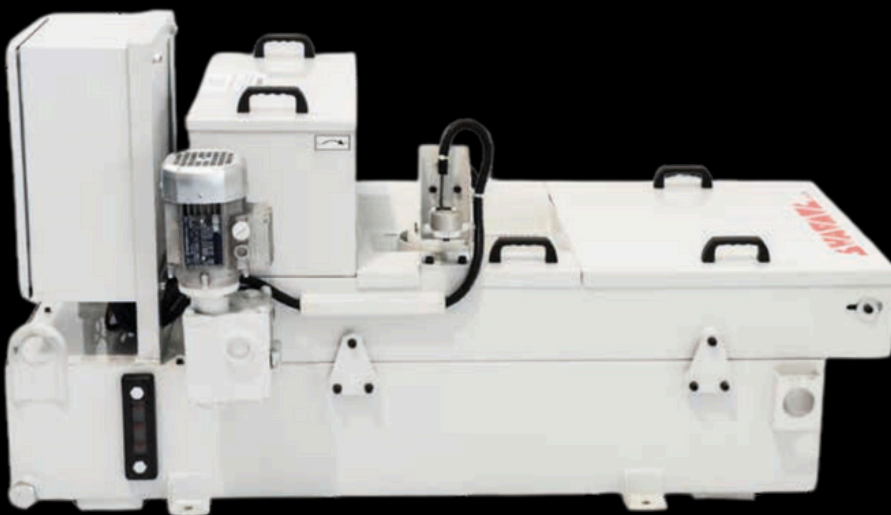

### Filter Rolls

Available in a variety of micron ratings, including 10, 20, 45, and 50 microns.



Model LMP	PBMF/ PBF 50	PBMF/ PBF 65	PBMF/ PBF 100	PBMF/ PBF 150	PBMF/ PBF 200	PBMF/ PBF 300	PBMF/ PBF 400
Length	1300	1400	1800	1800	2200	2500	2200
Width	550	800	800	1000	1000	1100	1500

# WATER TREATMENT



## How it works

Process Water Recycling systems enable the treatment and reuse of wastewater generated in the process from single machine to multiple lines with different capacities. With high-speed centrifugal and gradual treatment, wastewater is purified from particles and unwanted substances and recycled to the system.

Water treatment machines are used in a variety of industries, including:

- **Metalworking:** Paper band filters are used to remove metal chips and other contaminants from the effluent discharged from grinding machines and other metalworking equipment.
- **Plastics:** Paper band filters are used to remove plastic shavings and other contaminants from the effluent discharged from injection moulding machines and other plastics processing equipment.
- **Foundry:** Paper band filters are used to remove sand and other contaminants from the effluent discharged from casting machines and other foundry equipment.

These systems allow the filtered water to be reused, which can help to reduce water consumption and wastewater treatment costs.

### Benefits:

- Significant reduction in water consumption
- Reduced chemical usage.
- Environmental protection by preventing pollution.
- Recycling of valuable ores when processing precious stones, gold, or jewellery
- The system works in neutral waters (pH between 6.5-9.5).

	ARS25 B0	ARS25 B60	ARS25 MN500	ARS25 MN1000	ARS140 B1000
Capacity (Ltr/Hr)	300	300	300	300	300
Clean Water Tank Capacity (L)	-	30	270	556	482
Waste Water Tank Capacity (L)	-	30	135	260	338
Total Tank Capacity (L)	-	120	405	816	820
Sludge Container Capacity (KG)	2,5	2,5	2,5	2,5	22
Max. Clean Outlet Pressure (BAR)	0,5	0,5	0,5	0,5	0,3
Seperation Factor (G)	1800	1800	1800	1800	2010
Centrifugal Speed (RPM)	4100	4100	4100	4100	2750
Motor Power (kW)	1,5	1,5	1,5	1,5	5,5
Total Power (kW)	1,5	2	1,5	1,5	5,5
Measurements (MM)	702x413x780	680x800x800	1560x760x1392	2060x1080x1392	2120x1275x1695
Total Weight (KG)	115	160	290	335	335
Control Unit	SemiAuto	SemiAuto	SemiAuto	SemiAuto	SemiAuto
Chemical Dosing	-	Optional	Standard	Standard	Standard
Filtering	Centrifugal	Centrifugal	Centrifugal	Centrifugal	Centrifugal
Defoaming	Optional	Optional	Optional	Optional	Optional
Water Recycling Rate (%)	95	95	95	95	95



**MAGNETIC FINISHING  
MACHINES  
CATALOGUE PAGE**

# MAGNETIC FINISHING

The Sharmic Magnetic Finishing Machine utilises innovative magnetic field technology to move steel media rapidly, providing superior performance for deburring, polishing, descaling, and cleaning of nonferrous parts.

The process combines steel media, workpieces, and liquid compounds in a container placed on the machine. A powerful magnetic field is generated, which moves the magnetic steel pin media across the parts, delivering precise and effective results.

- Excellent for deburring and edge chamfering.
- Ideal for irregularly shaped parts, internal holes, and complex geometries.
- No deformation or surface damage.
- Maintains high accuracy of parts.
- Long-lasting steel media for extended use.
- Simple and user-friendly operation.
- Short processing times ranging from 5 to 15 minutes.
- Efficient in accessing difficult areas such as recesses, slots, and blind holes.

Model	Size	Max work load
MFM 830	425 X 550 X 1050	3KG
MFM 840	525 X 650 X 1050	5KG
MFM 850	660 X 800 X 1200	8KG



**CONTACT US FOR A FREE ANALYSIS**

**Sharmic Engineering, Baldwin Road, Stourport-On-Severn,  
Worcestershire, DY13 9AX**



TAILORED TO SUIT YOU



# ASSOCIATED PRODUCTS

# ACOUSTIC NOISE COVERS

- REDUCE ACOUSTIC NOISE LEVELS
- AVAILABLE IN ECO AND PREMIUM VERSIONS
- CUSTOM BUILT
- HEAVY DUTY
- SOUND PROOFING
- PNEUMATIC OR MANUAL CONTROL AVAILABLE
- FREE STANDING OR ATTACHED
- IMPROVE EMPLOYEE HEALTH
- REDUCE EMPLOYEE ABSENTEEISM



# CONTROL PANELS

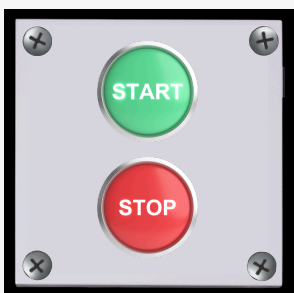

- BASIC ON/OFF SWITCHES
- OPTIONAL TIMERS
- OPTIONAL AUTOMATIC CONTROLS
- OPTIONAL LIGHT DISPLAY
- OPTIONAL REVERSE
- OPTIONAL SPEED CONTROL
- OPTIONAL WATER CONTROL
- OPTIONAL PLC CONTROL
- EMERGENCY STOP





# IS YOUR WORKSHOP TOO NOISY?

Our acoustic noise covers are designed to combat noise pollution. They can be free standing or attached to the machine, they are mainly used to absorb and reduce the noise by a considerable factor.

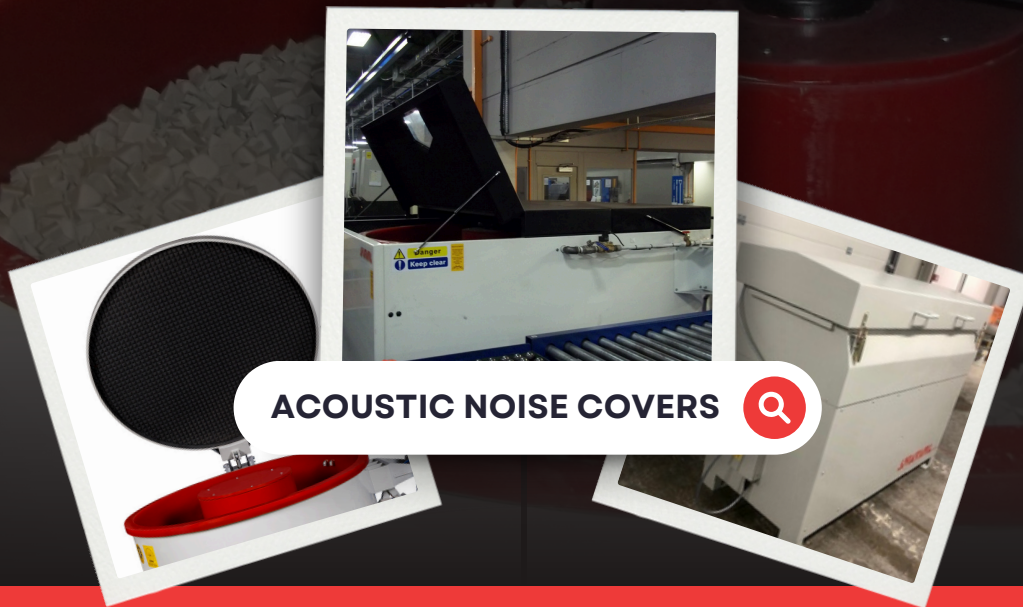

## Improving Employee Health

Noise pollution can cause a number of health problems, including hearing loss, tinnitus, stress, and high blood pressure. By reducing noise pollution, employers can help to improve the health of their employees.

## Reduced Employee Absenteeism

Noise pollution can make it difficult to concentrate and can lead to fatigue. By reducing noise pollution, employers can help to reduce employee absenteeism and improve productivity.

# LIQUID COMPOUND DOSING UNITS

---



- ANALOGIC SOLENOID DRIVEN DOSING PUMP
- CONSTANT FLOW RATE (FLOW RATE IN %)
- 3 DIFFERENT SELECTABLE PERFORMANCE SETUP
- WALL MOUNTING BRACKET SUPPLIED WITH INSTALLATION KIT
- POWER SUPPLY 100÷240VAC - 50/60HZ
- IP65 PROTECTION DEGREE
- STROKES FREQUENCY PERCENTAGE SETTING
- FLOW RATE SETTING FROM 0-100% OR FROM 0-20%
- REINFORCED PP HOUSING, SUITABLE FOR AGGRESSIVE WORKING
- FREE COMMISSIONING

---

# WASTE WATER TRANSFER PUMP

---

- 600 WATT, 230V MOTOR
- 195LTR/MIN MAX FLOW RATE
- MAX HEAD HEIGHT 9M
- PUMP OUTLET 1¼" BSP
- PUMPS AS LOW AS 3MM FROM THE FLOOR
- 10M LONG POWER CABLE
- COMPLETE WITH 1" AND ¾" MULTI-STEP HOSE ADAPTER
- TOUGH DURABLE BUILD
- SUITABLE FOR CLEAN WATER APPLICATIONS
- EN 60335-2-4:2003+A2:2010, EN 60335-1:2012+A11:2014



# FILTRATION WEIR TANK



- REMOVE THE SILT CONTAMINANTS
- UNWANTED WASTE WATER DISCHARGED
- 1.5MM THICK GALVANISED STEEL
- DRAIN PLUG & BUNG COME AS STANDARD
- ROLL TOP FOR STRENGTH & STABILITY
- 915MM LENGTH - 163LTR CAPACITY
- 1220MM LENGTH - 218LTR CAPACITY
- 457MM WIDTH
- 405MM DEEP
- BSEN ISO 1461



